

DP202 Digital Equaliser



Operators Manual

**XTA Electronics Ltd.
The Design House,
Vale Business Park,
Worcester Road,
Stourport-on-Severn,
Worcs. DY13 9BZ.
England**

**Tel: 01299 879977 (Intl. +44 1299 879977)
Fax: 01299 879969 (Intl. +44 1299 879969)
Web: <http://www.xta.co.uk>**



© XTA Electronics Ltd 10/2000

If you have any comments or suggestions about this manual, please contact XTA at the address above, or email manuals@xta.co.uk

Contents

Contents	3
Safety Warnings	5
Unpacking the DP202.....	5
Introduction	6
Front Panel Functions	8
Rear Panel Functions	9
Operating The DP202.....	10
DP202 Configurations	12
Parametric Equaliser modes	12
Parametric Equalisation Block diagrams	13
Parametric Equalisation and Limit Modes	14
Parametric Equalisation + Limit Block diagrams	15
Gain and <i>Delay</i> Function Screen	16
High and Lowpass Filters Function Screen.....	17
Parametric Equalisation Function Screen	18
Limiter Control Function Screen	19
Limiter View Function Screen.....	20
Memory Store	20
Memory Recall.....	21
Security System.....	21
MIDI Operation	22
Equalisation Curves.....	23
Specifications.....	25
Operating Notes	26
Warranty	27

Thanks

Thank you for choosing the XTA DP202 for your application. Please spare a little time to digest the contents of this manual, so that you obtain the best possible performance from this unit.

All XTA products are carefully engineered for world class performance and reliability.

If you would like further information about this or any other XTA product, please contact us.

We look forward to helping you in the near future.

XTA Electronics Ltd.

Safety Warnings

Please note the following information, which is provided for your safety:

- Check correct operating voltage is set on the power supply before connecting mains power. This voltage is confirmed on the voltage label affixed to the rear of the unit. The voltage selector switch is located inside the DP202 - Refer adjustment to qualified personnel. Do not expose this unit to rain or moisture.
- Do not expose this unit to excessive heat.
- Replace all fuses with the correct type only.
- Do not remove the covers from this unit. There are no user serviceable parts inside - refer all servicing to qualified personnel.

The mains power cord is fitted with a safety earth (ground) connection. Do not operate this unit with this connection removed.

Unpacking the DP202

After unpacking the unit please check carefully for damage. If damage is found, please notify the carrier concerned at once. You, the consignee, must instigate any claim. Please retain all packaging in case of future re-shipment.

Introduction

The DP202 is a compact and powerful DSP based programmable equaliser which combines the functions of multiple conventional products in a compact 1U high unit. To achieve this the DP202 provides:- 2 input 2 output format, 4 configurations, 2 x 8 bands of parametric equalisation, variable High and Lowpass filters, 2 output limiters and digital level controls for each output. A delay option is available to order and provides 0 to 682mS delay for each output. Each parametric section can be positioned between 20Hz & 20kHz, features a wide range of Q's and has +15dB to -30dB gain available, controllable in 0.1dB steps. The first two sections can also be designated a Low or High frequency shelving filter. MIDI control and user memories are provided, and also a security 'lock-out' function for all controls. The DP202 is also available with optional AES/EBU inputs and outputs. The DP202 is designed for quick adjustment via easy-to-use front panel controls, or it can be controlled externally by XTA's **AudioCore** Windows™ control software, along with both existing and future **AudioCore** series products.

Features

- **Superb audio quality** : Carefully optimised Double Precision processing plus 40 bit internal data path for exceptional dynamic range and sonic quality.
- A flexible 2 input, 2 output multi-mode format featuring a choice of dual and stereo 8 band parametric equalisers and dual and stereo 8 band parametric equalisers with limiters.
- Each parametric section provides +15dB to -30dB of gain at any centre frequency 20Hz - 20kHz with a wide range of Q's from 0.4 to 128. All parameters feature fine resolution with 1/24 octave frequency steps, 0.1dB gain increments and multiple Q settings.
- Parametric sections 1 and 2 can be set for LF & HF shelving response.
- Two high performance limiters are provided, featuring a wide range of control over Attack, Release and Threshold parameters. A limiter display function provides two 'over-limit' meters simultaneously on the LCD display.
- Variable High and Low pass filters for each output can be set for 12 or 24dB / octave slopes and a choice of Bessel, Butterworth or Linkwitz-Riley responses are available.
- Three velocity-sensitive rotary encoders provide a familiar and easy to use control format with all filter information displayed simultaneously on a backlit LCD display.
- Channel and section 'Flat' keys are provided allowing A/B comparison, or equalisation to be pre-set and then dropped in.
- Delay of up to 682mS is optionally available and can be independently set for each output with a minimum increment of 21µS.

- Comprehensive standard specification includes 40 memories, MIDI for external control & linking master / slave units, selectable operating level and security lock-out function.
- The DP202 provides exceptional quality with a full 103dB dynamic range, high sampling rate and minimal filtering.
- Wide range digital control of level is provided for each output. This also allows mute to be applied to any output.
- AES / EBU digital inputs and outputs are available as an option, with optical I/O also available to special order.

Front Panel Functions

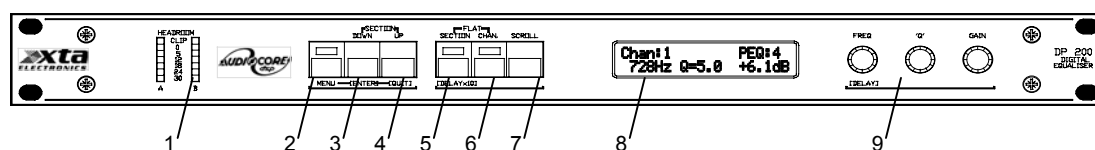

1. **Headroom Meter** - Displays available headroom before system clipping occurs. The bottom six LED's display between 30dB and 0dB of input headroom, with the orange 0dB LED set at 3dB below clipping. The top, red LED displays digital overflow and can therefore light without all other LED's becoming illuminated.
2. **Menu Key** - Selects last used menu choice to be previewed on the LCD display. Pressing a second time selects the next menu choice. Menu selections can also be viewed more quickly by using the Frequency control.
3. **Down Key** - Moves the display backwards through the list of available function screens for the current output. [**Enter Key**] - With the menu LED lit, this key performs the 'enter' function allowing the option for the current menu selection to be displayed and then the chosen option confirmed.
4. **Up Key** - Moves the display forwards through the list of available function screens for the current output. [**Quit key**] - With menu LED lit, this key performs the 'quit' function, returning the unit to the basic default operating mode from the existing menu selection.
5. **Section Flat Key** - Allows the currently displayed equaliser section or limiter to be bypassed. The LED shows the status of the current section. (Note: The High and Lowpass filters can not be bypassed using this method.) When the display is showing 'delay time' holding this key down will cause the delay time control to be adjusted in larger increments allowing quick adjustment. If an output channel is selected and the display is showing 'Delay time', output phase will also be shown.
6. **Chan. Flat Key** - Allows all the equaliser sections apart from the high and lowpass filters to be bypassed for the current channel. The LED shows the status of the current channel. The overall channel gain control may be set to 0dB by this action if required, by selecting the 'Gain Bypass Option' (see menu options).
7. **Scroll Key** - Scrolls the screen through the available channels for the current configuration.
8. **LCD Display** - Shows menu options, output information and various parameters dependant on the menu selection.
9. **Parameter Controls** - The three rotary encoders allows the relevant parameter to be adjusted.

Rear Panel Functions

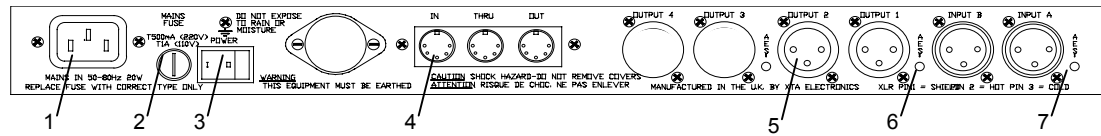

1. **Mains Power** - is connected via a standard IEC socket. A compatible power cord is supplied with the unit.
2. **Mains Fuse** - is located in a finger-proof fuseholder adjacent to the mains inlet. Always replace this fuse with the correct type as shown on the rear panel legend.
3. **Power Switch** - a double pole rocker switch isolates both live and neutral connections.
4. **MIDI** - In / Thru and Out connections are provided via standard 5 pin DIN sockets. See page **Error! Bookmark not defined.** for more information.
5. **XLR Inputs and Outputs** - Separate 3 pin XLR connectors are provided for each audio input and output. All terminations are fully balanced where pin 2 = Hot, pin 3= Cold and pin 1 = Screen (shield). See page **Error! Bookmark not defined.** for more information.
6. **Digital Output 1+2 Switch** - pressing this recessed switch will route the AES digital format of outputs 1 and 2 via output 1's XLR connector, if the AES/EBU option is fitted.
7. **Digital Input Switch** - pressing this recessed switch will change XLR Input A to a 2 channel AES digital format input, if the AES/EBU option is fitted.

Operating The DP202

Preliminary Set-up

The following procedure should be followed when first installing the DP202.

1. Select correct unit configuration via menu.
2. Set maximum input level (operating level) via menu.

To set the above options, press Menu to enter Menu Mode and scroll through menus until required choice is found, using menu or scroll keys or the frequency control.

When the required menu choice is found, press Enter key, then use the scroll key to view options. The currently used option will be marked by a '*' star. To confirm a new option press enter again whilst required option is selected.

Note: After 15 seconds the unit will return to normal 'default' mode. Repeat above instructions to return to menu mode.

Menu Selections

The following menu selections are available. To view menu selections see instructions under preliminary set-up above.

Unit Configuration: Sets unit into one of the 4 operating modes: **Dual 8 Band** parametric, **Stereo 8 band** parametric, **Dual 8 band & limiters**, **Stereo 8 band & limiters**. See page 12 for more information.

Maximum Input Level: Sets operating level to optimise dynamic range by increasing input level and decreasing output level. Selectable to +3dBu, +8dBu, +15dBu or +20dBu. See page **Error! Bookmark not defined.** for more information.

Inputs Dual / Mono: Selects two inputs; A and B (Dual) or one input A (Mono). With 'mono' selected this allows each output to control different zones derived from a single input.

Bypass Chan. Gain Mode: Selects whether channel flat function will set the overall channel gain to 0dB or not effect it.

Limiter Link Mode: Once selected, if any one limiter's threshold is exceeded, equal gain reduction will be applied to both limiters.

Memory Store: Allows up to 40 settings to be stored. See page **Error! Bookmark not defined.** for more information.

Memory Recall: Allows recall of all currently used memories, as selected via the frequency control. See page 21 for more information.

Security System: Allows a security number to be chosen via the frequency control and confirmed using the Enter key. With this function selected all controls are rendered inoperative to avoid unauthorised adjustments.

Please keep a safe copy of the chosen security number. - This must be re-entered to 'unlock' the security system. See page 21 for more information.

Interface Set-up: Allows external interface to be set-up. This is via MIDI on the standard unit. The unit can be placed in Off, Master, Slave modes and a MIDI channel number assigned via the parameter control. The basic MIDI system uses 'program change' controls to automatically recall memories when in the Slave mode or to send a 'program change' control when a memory is manually recalled when in Master mode. See page **Error! Bookmark not defined.** for more information.

Remote ID: Selects a unique identification number for computer control.

Cloning Number: Allows the unique combination of menu options from one unit to be quickly copied to other units.

AES Receive Mode: Selects the input source for the unit to be either Analogue, AES, Auto (the unit uses the analogue source unless there is a locked AES signal present) or Reference (the unit uses the analogue input and the internal sampling clock will lock to AES signal if it is present). Available only if the AES option is fitted.

AES Diagnostics: Shows the complete status of the input AES signal. Available only if the AES option is fitted.

DP202 Configurations

Introduction

To simplify set-up of the DP202, 4 configurations are menu selectable. These fall into two groups:- Parametric equalisers and Parametric equalisers with limiters. For detailed information on these modes please study the block diagrams along with the following descriptions. Within each group, stereo modes are available to provide precise 'ganged' parameter adjustment for stereo sources.

Parametric Equaliser modes

Two modes are provided:- Dual 8 band and Stereo 8 Band.

All modes feature a total of 16 bands of fully flexible parametric equalisation split between 2 outputs, with sections 1 and 2 on each output selectable respectively to L.F. and H.F. shelving response. Separate high and low pass filters are provided for each output with adjustable turnover frequency and a choice of slopes. Output gain is also adjustable for each output. On units with delay option fitted, delay time can also be set, between 0 and 682 milliseconds for each output.

Equalisation (see page **Error! Bookmark not defined.** for more information)

Each identical parametric section can be positioned at any frequency 20Hz to 20kHz and features a wide range of 'Q's to produce response curves ranging from broad to notch. 15dB boost and 30dB cut is provided with 0.1dB resolution. Frequency parameter features 1/24 octave resolution for precise control. Since all filtering is achieved in DSP all settings are re-settable with absolute accuracy and in stereo mode parameters track identically, Very narrow band notch filters can be achieved, (maximum Q=128). Unlike analogue filters these 'tight' Q filters are entirely stable, maximum notch depth is 30dB.

Parametric filters are carefully implemented using Double Precision processing. This method is costly in terms of processing power but yields substantial benefits in terms of the DP202's exceptional noise performance and greatly improved low frequency stability.

High and Low Pass Filter slopes

A choice of Bessel or Butterworth slopes at 12dB per octave and Bessel, Butterworth or Linkwitz-Riley at 24dB per octave are provided. It should be noted that the turnover frequency displayed on the DP202 is the -3dB point for all slopes except 24dB Linkwitz-Riley where the -6dB point is shown. If the -6dB point is to be used for the Bessel or Butterworth filter, take the required turnover frequency, multiply this by the appropriate factor from the following table and then select the closest available frequency on the DP202's display.

Filter Type	High pass filter factors	Low pass filter factors
Bessel 12dB/octave	1.45	0.69
Butterworth 12dB/octave	1.31	0.76
Bessel 24dB/octave	1.35	0.74
Butterworth 24dB/octave	1.15	0.87

Parametric Equalisation Block diagrams

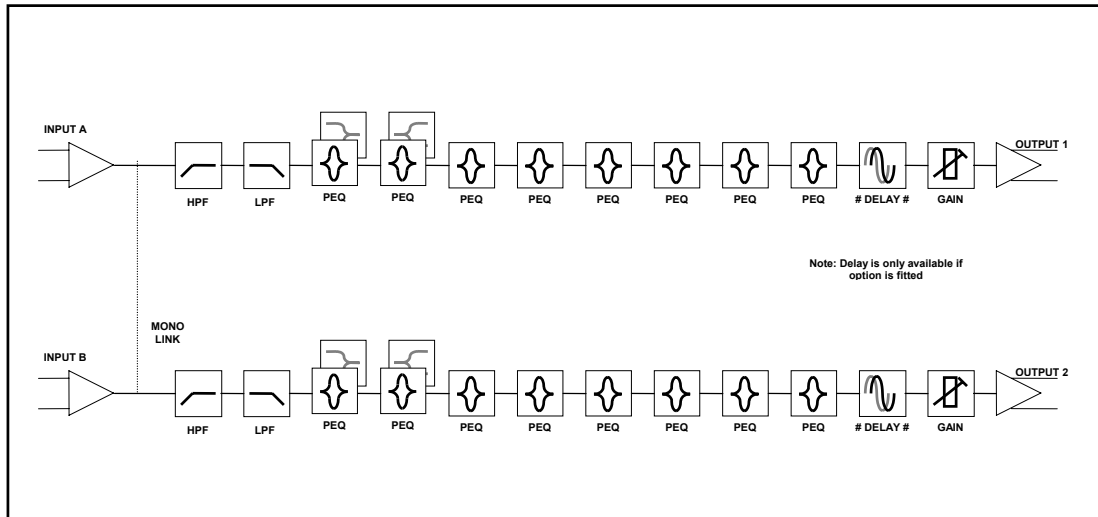

Figure 1 – Dual 8 Band Parametric

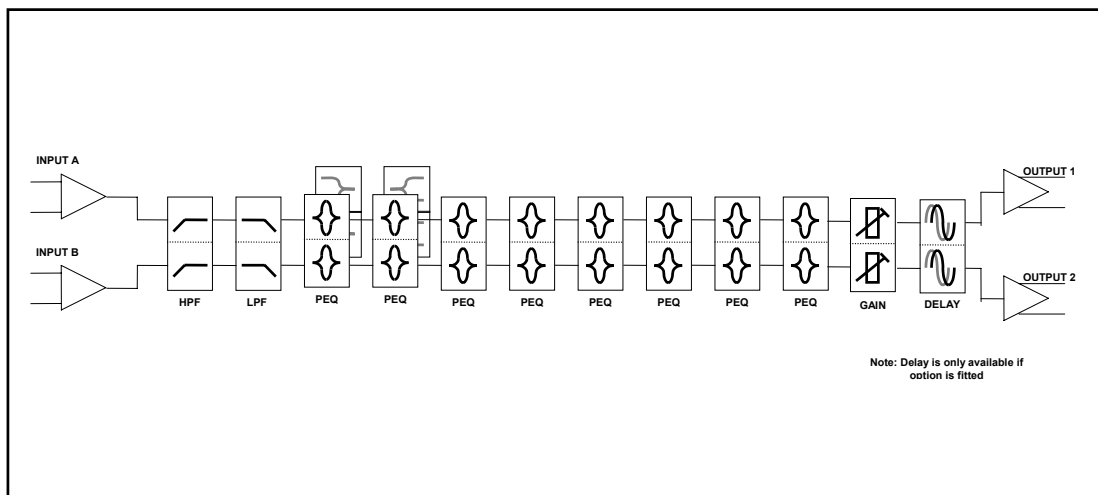

Figure 2 – Stereo 8 Band Parametric

Parametric Equalisation and Limit Modes.

Two modes are provided :- Dual 8 band + limit and Stereo 8 band + limit.

All modes features 8 bands of fully flexible parametric equalisation for each output, with sections 1 & 2 of each output selectable respectively to L.F. and H.F. shelving response. Output gain is adjustable for each output and a limiter is provided for each output. On units with delay option fitted, delay time can also be set, between 0 and 682 milliseconds for each output.

Equalisation (see page **Error! Bookmark not defined.** for more information)

Each identical parametric section can be positioned at any frequency 20Hz to 20kHz and features a wide range of 'Q's to produce response curves ranging from broad to notch. 15dB boost and 30dB cut is provided with 0.1dB resolution. Frequency parameter features 1/24 octave resolution for precise control. Since all filtering is achieved in DSP all settings are re-settable with absolute accuracy and in stereo mode parameters track identically, Very narrow band notch filters can be achieved, (maximum Q=128). Unlike analogue filters these 'tight' Q filters are entirely stable, maximum notch depth is 30dB.

Parametric filters are carefully implemented using Double Precision processing. This method is costly in terms of processing power but yields substantial benefits in terms of the DP202's exceptional noise performance and greatly improved low frequency stability.

Output Limiters (see pages **Error! Bookmark not defined.** & **Error! Bookmark not defined.** for more information)

High performance digital limiters are provided for each output with control over attack time, release time and threshold level parameters (see page **Error! Bookmark not defined.**). This level of control allows the user to balance the required subjective quality of the limiter against the driver protection requirements. It does also mean that an incorrectly set limiter may sound awful! In particular, as with all limiters, using too fast an attack or release time will result in excessive low frequency distortion. Please therefore ensure that all limiters are bypassed during initial set-up and use the following limiter parameter set-ups as a starting point.

High Pass Filter Frequency	Attack	Release
less than 50Hz	80mS	S
50Hz - 200Hz	80mS	M
200Hz - 400Hz	60mS	M
400Hz - 1k3Hz	40mS	M
1k3Hz - 4kHz	20mS	M
4kHz - 20kHz	10mS	M

Once set, the limiter view screen can be set (see page **Error! Bookmark not defined.**) this simultaneously displays the amount of gain reduction for both outputs on two separate 'over limit' meters.

If required the limiter-link function can be selected via the menu system. Once selected, if any one limiter's threshold is exceeded, equal gain reduction will be applied to both limiters. In this mode, the limiter meters still show the amount of gain reduction that would be applied to each output if they were not linked. This allows the user to identify which output is predominantly over threshold.

Parametric Equalisation + Limit Block diagrams

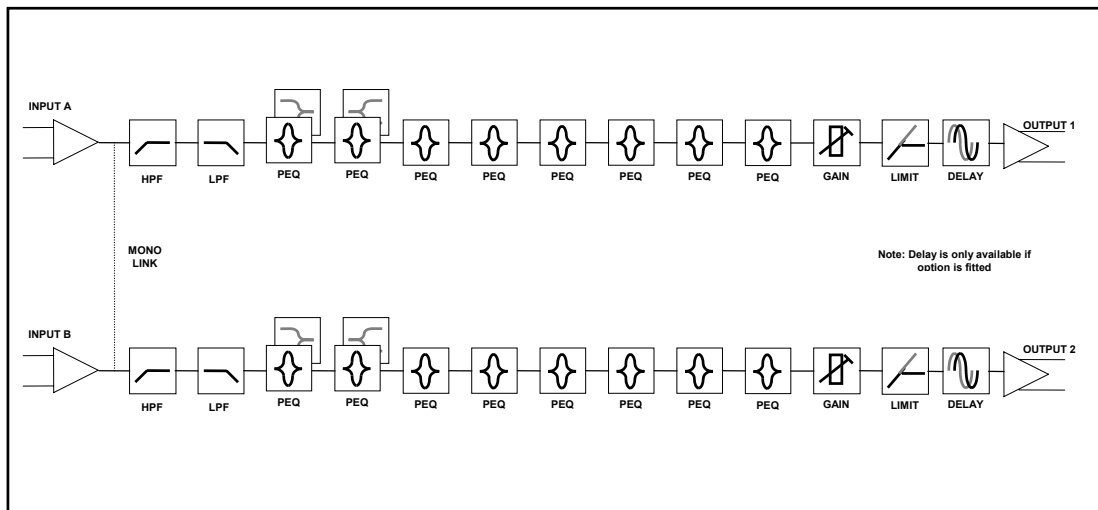

Figure 3 – Dual 8 Band Parametric + Limiters

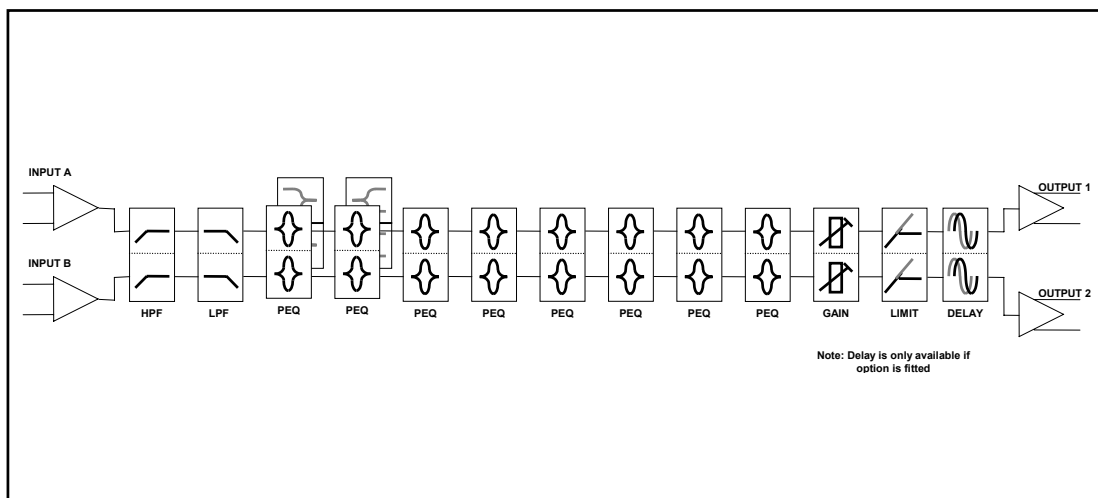
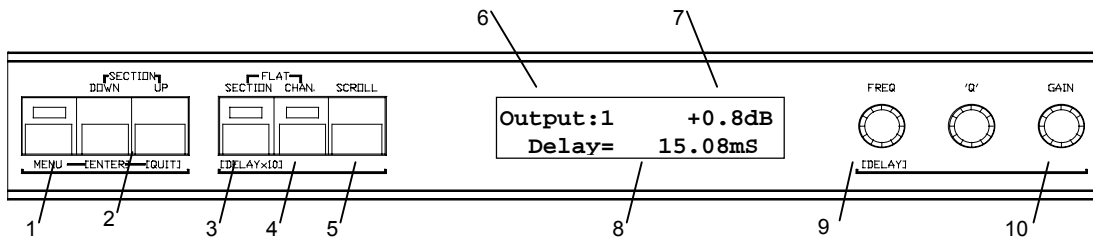

Figure 4 – Stereo 8 Band Parametric + Limiters

Gain and *Delay* Function Screen

The gain function screen controls the overall gain of an individual output. On units with delay option fitted control and display of output delay is also available.



1. **Menu Key** - Selects menu functions.
2. **Down and Up Keys** - Moves the display backwards and forwards through the list of available function screens for the current output.
3. **[Delay *10] Key** - Holding this key down will cause the delay time control to be adjusted in 1 millisecond steps allowing quick adjustment. ☒
4. **Chan. Flat Key** - Allows all the equaliser sections apart from the high and lowpass filters to be bypassed for the current channel. The LED shows the status of the current channel. The overall channel gain control may be set to 0dB by this action if required, by selecting the 'Gain Bypass Option' (see menu options).
5. **Scroll Key** - Scrolls the screen through the available channels for the current configuration.
6. **Output** - Shows current output channel. A '+' sign indicates a 'ganged' pair.
7. **Gain** - The actual gain setting for current output channel.
8. **Delay** - The actual delay setting for current output channel. ☒
9. **Delay Control** - Adjusts the delay in 21 microsecond steps or 1 millisecond steps if the [Delay *10] is pressed. ☒
10. **Gain Control** - Adjusts the current output channel gain in 0.1dB steps. The range is from +15dB to -40dB and mute.

☒ = These functions only available with delay option fitted.

High and Lowpass Filters Function Screen

Each Output has high and lowpass filters which are fully controllable in terms of filter slope and turnover frequency.

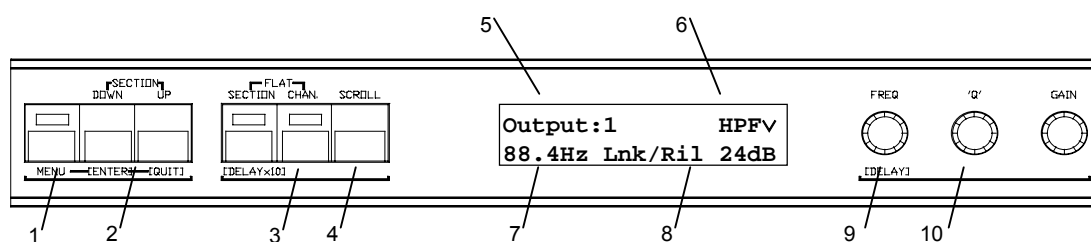

1. **Menu Key** - Selects menu functions.
2. **Down and Up Keys** - Moves the display backwards and forwards through the list of available function screens for the current output.
3. **Chan. Flat Key** - Allows all the equaliser sections apart from the high and lowpass filters to be bypassed for the current channel. The LED shows the status of the current channel. The overall channel gain control may be set to 0dB by this action if required, by selecting the 'Gain Bypass Option' (see menu options).
4. **Scroll Key** - Scrolls the screen through the available channels for the current configuration.
5. **Output** - Shows current output channel. A '+' sign indicates a 'ganged' pair.
6. **Type** - The filter type: Highpass (HPF) or Lowpass (LPF).
7. **Frequency** - The turnover frequency for current output channel. For Bessel and Butterworth types this is the 3dB point, for Linkwitz-Riley the 6dB point.
8. **Filter type and slope** - Available filters are Bessel 12 and 24dB per octave, Butterworth 12 and 24dB per octave and Linkwitz-Riley 24dB per octave.
9. **Frequency Control** - Adjusts the turnover frequency of the filter. For highpass filters this ranges from 10Hz to 16kHz and for the lowpass 102Hz to 22kHz. On each output the unit will not allow the high and lowpass filters to overlap (highpass greater than lowpass), attempting to do so will cause the unit to flash the message 'High / Low Conflict'.
10. **Q Control** - Adjusts the filter type (see 8).

Parametric Equalisation Function Screen

Each identical section can be positioned at any frequency from 20Hz to 20kHz and features a wide range of Q's to produce response curves ranging from shelving to notch. 15dB's Boost and 30dB's Cut is provided with 0.1dB resolution. Frequency parameter features 1/24 octave resolution for precise control.

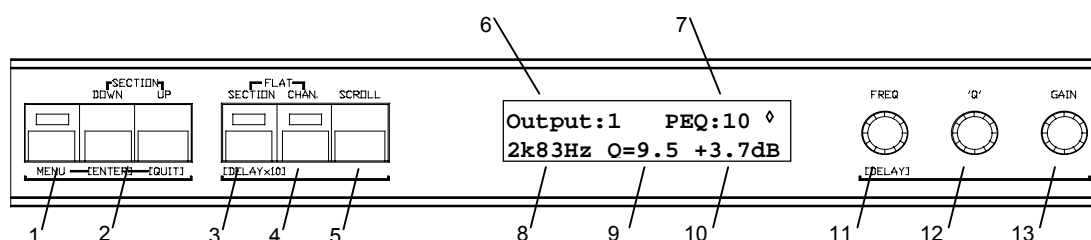

1. **Menu Key** - Selects menu functions.
2. **Down and Up Keys** - Moves the display backwards and forwards through the list of available function screens for the current output.
3. **Section Flat Key** - Allows the current equaliser section to be bypassed for the current channel. The LED shows the status of the current section.
4. **Chan. Flat Key** - Allows all the equaliser sections apart from the high and lowpass filters to be bypassed for the current channel. The LED shows the status of the current channel. The overall channel gain control may be set to 0dB by this action if required, by selecting the 'Gain Bypass Option' (see menu options).
5. **Scroll Key** - Scrolls the screen through the available channels for the current configuration.
6. **Output** - Shows current output channel. A '+' sign indicates a 'ganged' pair.
7. **PEQ** - Shows the filter section number for current output channel.
8. **Frequency** - Shows the centre frequency of the filter, from 20.3Hz to 20k2Hz. For Low and High shelf modes the frequency range is from 20.3Hz - 1k00Hz and 1k00Hz - 20k2Hz.
9. **Q** - Shows the 'Q' of the filter, from 0.4 - 128 (higher Q's equal sharper filters) or for PEQ numbers 1 and 2, which can be switched into Low and High shelf modes respectively; the mode.
10. **Gain** - Shows the gain of the current filter.
11. **Frequency Control** - Adjusts the centre frequency of the filter in 1/24 octave steps.

12. **Q Control** - Adjusts the 'Q' of the filter. For PEQ numbers 1 and 2, adjusting the 'Q' below 0.4 will switch the filter into Low and High shelf modes respectively

13. **Gain Control** - Adjust the gain of the filter from -30dB to +15dB in 0.1dB steps, except -25dB to -30dB (1dB step). For Low and High shelf modes this is restricted to ± 15 dB.

Limiter Control Function Screen

For configurations that allow limiters.

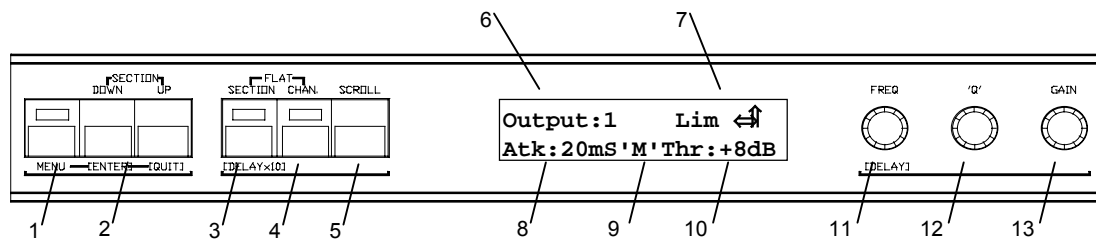

Note:- Please see page 14 for limiter operating guidance.

- 1. Menu Key** - Selects menu functions.
- 2. Down and Up Keys** - Moves the display backwards and forwards through the list of available function screens for the current output.
- 3. Section Flat Key** - Allows the current limiter to be bypassed for the current channel. The LED shows the status of the current limiter
- 4. Chan. Flat Key** - Allows all the equaliser sections apart from the high and lowpass filters to be bypassed for the current channel. The LED shows the status of the current channel. The overall channel gain control may be set to 0dB by this action if required, by selecting the 'Gain Bypass Option' (see menu options). Note: This key does not bypass the limiter.
- 5. Scroll Key** - Scrolls the screen through the available channels for the current configuration.
- 6. Output** - Shows current output channel. A '+' sign indicates a 'ganged' pair.
- 7. Lim** - Shows the amount of gain reduction for the current limiter as a real time bargraph in 1dB steps, from 0 to 9dB. In stereo modes, the output with the most gain reduction applied is displayed.
- 8. Atk** - Shows the limiter attack time, from 1 to 99 milliseconds.
- 9. Rel** - Shows the limiter release time as **Fast**, **Medium** or **Slow**. In the **Fast** setting the release time will be 4 times the Attack time. For **Medium** and **Slow** it will be 8 and 16 times respectively.

10. **Thr** - Shows the threshold point of the limiter in dBu. The range is +20dB to -27dB in 1dB steps, depending on the operating level of the unit.
11. **Frequency Control** - Adjusts the attack time of the limiter.
12. **Q Control** - Adjust the release time of the limiter.
13. **Gain Control** - Adjust the threshold point of the limiter.

Limiter View Function Screen

For configurations that allow limiters.

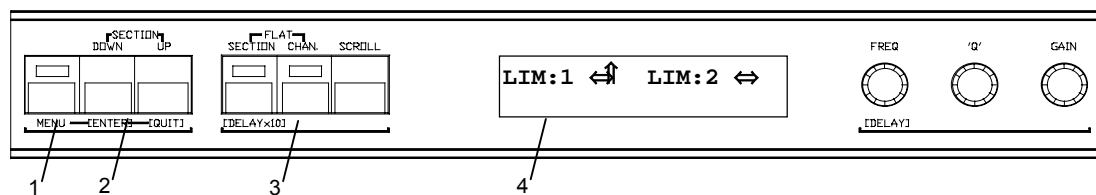

1. **Menu Key** - Selects menu functions.
2. **Down and Up Keys** - Moves the display backwards and forwards through the list of available function screens for the current output.
3. **Chan. Flat Key** - Allows all the equaliser sections apart from the high and lowpass filters to be bypassed for the current channel. The LED shows the status of the current channel. The overall channel gain control may be set to 0dB by this action if required, by selecting the 'Gain Bypass Option' (see menu options). Note: This key does not bypass the limiter.
4. **Display** - Shows the amount of gain reduction for all the available limiters as real time bargraphs in 1dB steps, from 0 to 9dB. See page 15 for more information.

Memory Store

To store to a location from the 40 user-selectable memories press 'MENU' and select Memory Store using menu / scroll keys or parameter control. Press 'ENTER' to load selection. If after 15 seconds no store has been implemented, the unit will return to the default mode.

Configuration - shows the current configuration used for the stored memory.

Memory No. - shows the memory number selected for storing. The next available empty memory is automatically selected, but any memory number can be chosen using the frequency control. Previously used memories are identified by a '?'.

Frequency Control - used to select required memory.

[Enter] key - Pressing this key stores all current parameters into the chosen memory. Previously used memories, (identified by a '?' after Mem No), must be over-written by pressing 'ENTER' again. Once stored, display shows: "Parameters stored" and unit returns to default mode.

Note A: A configuration must be currently in use before it can be recalled from memory. This eliminates the possibility of recalling a different configuration than that currently in use.

Memory Recall

Press 'MENU' and select Memory Recall using menu / scroll keys or parameter control. Press 'ENTER' to load selection. If after 15 seconds no recall has been implemented, the unit will return to the default mode.

Configuration - shows the current configuration used for the recalled memory.

Memory No. - shows the memory number selected for recalling. Use the frequency control to select the required memory. Only memory numbers containing stored information will be displayed.

Frequency Control - used to select required memory.

[Enter] key - Press this key to recall the memory number shown on the display.

Security System

Press 'MENU' and select Security System using menu / scroll keys or parameter control. Press 'ENTER' to load selection. Press 'ENTER' again to access security system information.

IMPORTANT - Please Note that once the security system is initiated only re-entering the correct code number will 'unlock' the DP202's functions. Please note Code Number !

Security System Status - shows on or off status for the security system.

Security Code No. - shows the code number currently selected. Any number between 0 & 9999 can be chosen via the frequency control.

Frequency Control - Allows the required security code number to be selected. This number must be written down and saved for future use.

Section Down key - Once the required security number has been selected, pressing this key initiates the security mode.

Note 2: To 'unlock' security system, enter security system via 'MENU' key, enter code number with frequency control and press the 'section down' key.

Note 3: If the security code number is inadvertently lost contact your local XTA sales office.

MIDI Operation

The DP202 is supplied with a MIDI interface as standard. The unit can be placed in Off, Master and Slave modes.

In 'Slave' mode the DP202 will monitor MIDI messages on the MIDI input connector and will respond to 'program change' commands from either another DP202 (set in 'Master' mode), or a separate MIDI events controller by recalling a DP202 memory corresponding to the 'program change' number. In this way, changes in delay time, gain and equalisation can be instantly implemented. MIDI channel numbers 1 to 16 plus 'All' (omni) are selectable.

In 'Master' mode the DP202 will send a MIDI 'program change' command via the MIDI output connector when a memory is recalled. The 'program change' number is the same as the DP202 memory number being recalled (i.e. 1 to 40), therefore if a Master DP202 is used to control a number of Slave DP202 units, the correct setting must be loaded into the same memory number on each unit. In 'Master' mode MIDI channel numbers 1 to 16 are selectable.

Press 'MENU' and select Interface Set-up using menu / scroll keys or parameter control. Press the 'section down' key to load selection. Use frequency control to select between Slave, Master and Off modes and confirm by pressing the 'section down' key .

MIDI Channel Number - shows Slave or Master MIDI channel number. The active channel number is identified by a '*'.

Frequency Control - Allows the channel number to be adjusted.

Enter key - Pressing this key confirms the channel number currently selected as active.

Equalisation Curves

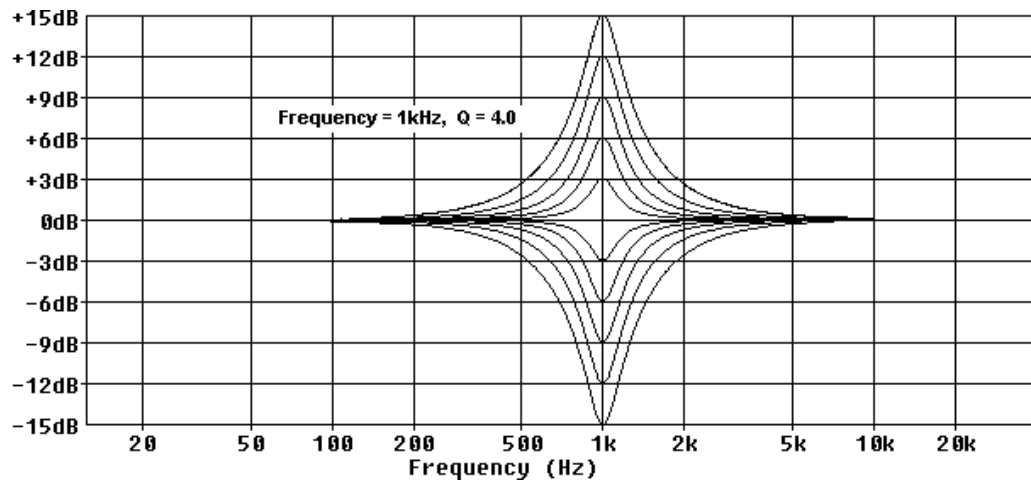

Figure 1 - Parametric filter gain curves.

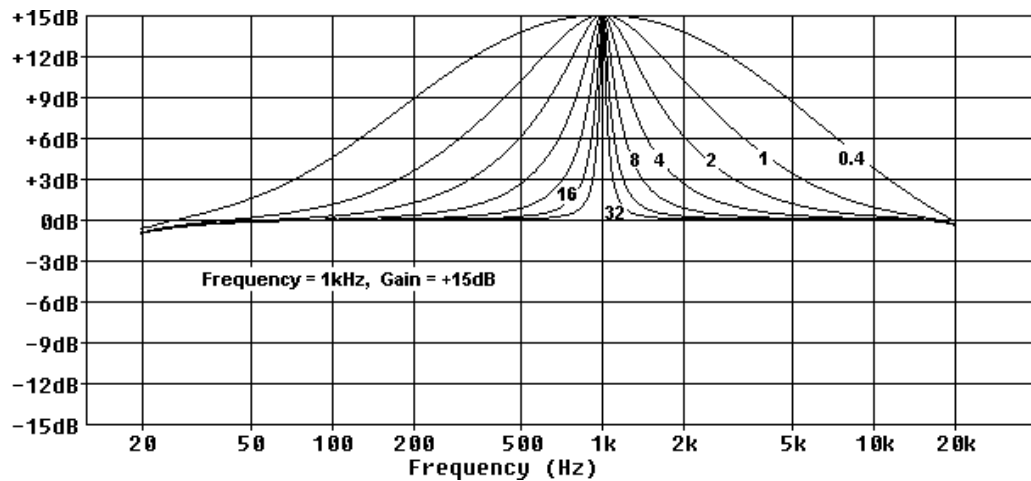

Figure 2 - Parametric filter 'Q' curves.

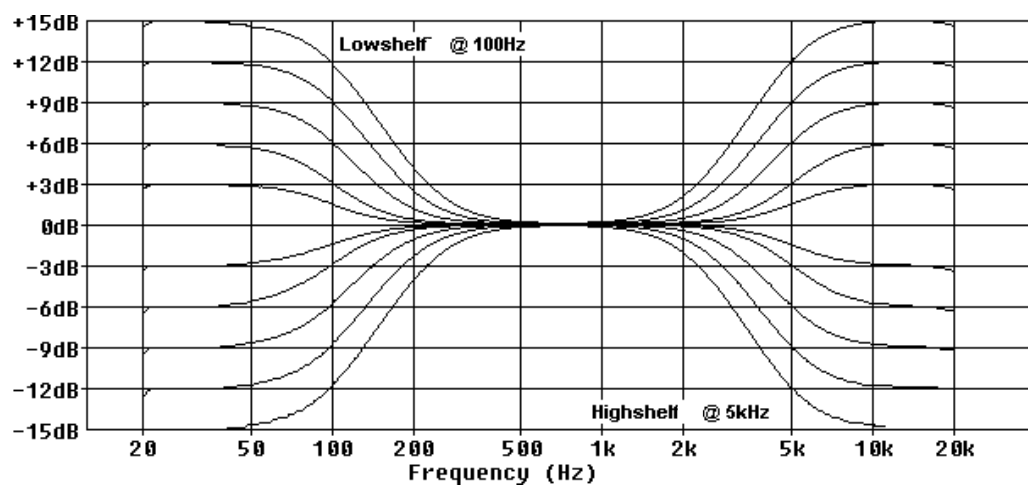

Figure 3 - Parametric filter High and Low shelf curves.

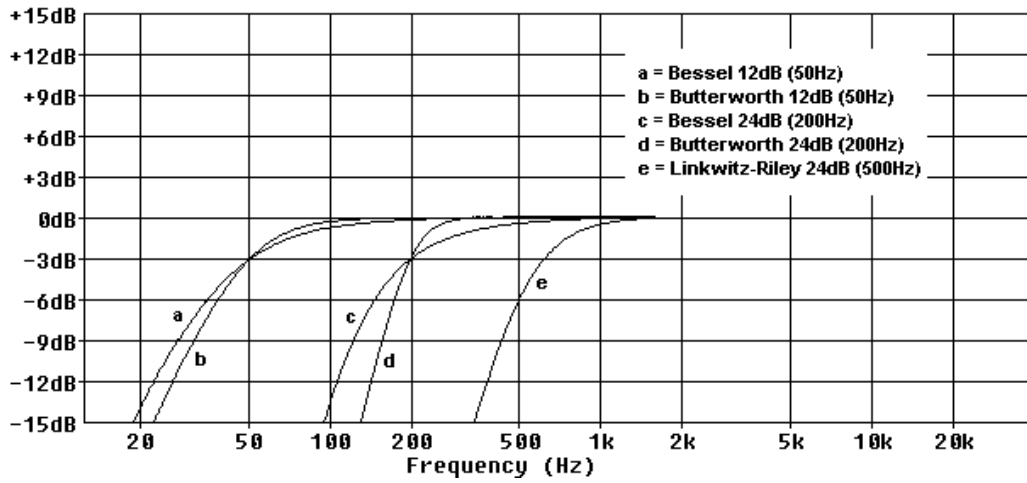

Figure 4 - Highpass filter curves.

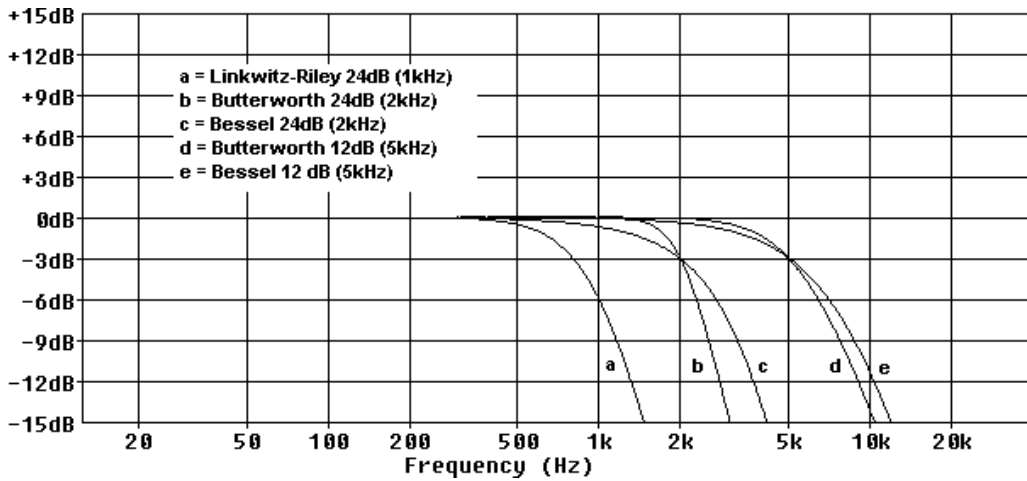

Figure 5 - Lowpass filter curves.

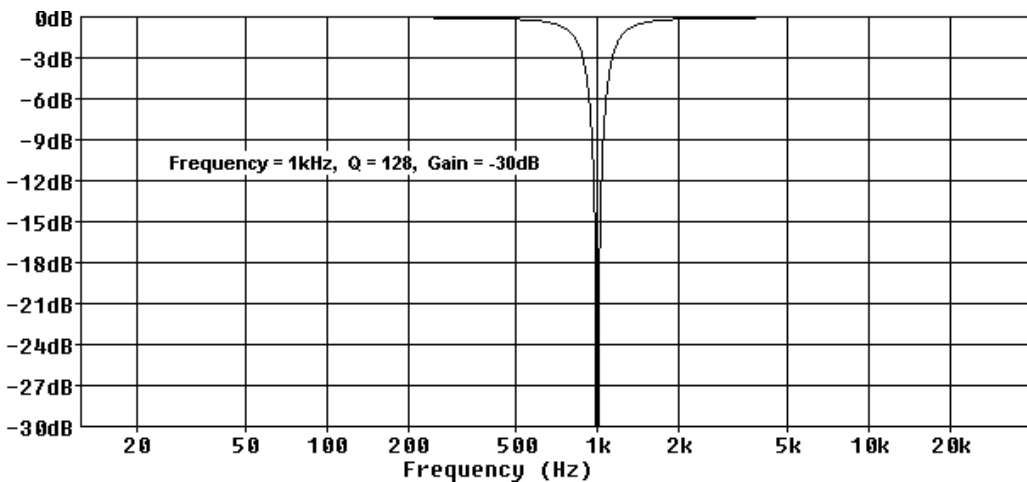

Figure 6 - Parametric filter with high 'Q' to achieve notch response.

Specifications

Inputs	Two electronically balanced. ◆
Impedance	> 10k ohms.
CMRR	>65dB 50Hz - 10kHz.
Outputs	Two electronically balanced. ◆
Source Imp	< 60ohms.
Min. Load	600ohm.
Max. Level	+20dBm into 600 ohm load.
Frequency Resp.	±0.5dB 20Hz - 20kHz.
Dynamic Range	>103dB 20Hz -20kHz. unwt'd.
Distortion	< 0.02% @ 1kHz, +18dBm.
Maximum Delay	682 mS. (increment 21 µS) with delay option
Output gain	Adjustable +15dB to -40dB in 0.1dB steps and mute.
Input gain	Adjustable 0dB to -40dB in 0.1dB steps. (crossover modes only)
Parametric Equalisation	
Filters	8 Sections per output (16 in total).
Filter gain	+15dB to -30dB in 0.1dB steps.
Centre frequency	20Hz - 20kHz, 1/24 octave steps. (240 positions)
Filter Q	0.4 to 128
(Sections 1 & 2 switchable to Shelving response)	
Low frequency	20Hz - 1kHz
High frequency	1kHz - 20kHz
Shelf gains	±15dB in 0.1dB steps.
High and Lowpass Filters	
Filters	1 of each per output.
Frequency (HPF)	10Hz - 16kHz, 1/24 octave steps.
Frequency (LPF)	60Hz - 22kHz, 1/24 octave steps.
Response	Bessel / Butterworth 12/18/24dB per octave and Linkwitz-Riley 24dB per octave.
Limiters	
Threshold	+20dBu to -27dBu (dependant on operating level).
Attack time	1 to 99 milliseconds.
Release time	4, 8 or 16 times the attack time.(S low, M edium, F ast)
Operating level	Headroom selectable +3dB, +8dB, +15dB & +20dB.
Display	2 x 20 character backlit LCD.
Headroom meter	2 x 7 point, -30dB to clip.
Connectors	
Inputs	3 pin female XLR.
Outputs	3 pin male XLR.
MIDI	In / Out / Thru 5 pin DIN.
Power	3 pin IEC.
Power	110 / 220 V ±15% @ 50/60Hz.
Consumption	< 20 watts.
Weight	3.5kg. Net (4.8kg. Shipping)
Size	1.75"(1U) * 19" * 11.8" (44 * 482 * 300mm) excluding connectors.
Optional Interfaces	RS232 (9 way DEE), RS422 (9 way DEE) and RS485 (8way RJ45 x 2). These options also provide closed-contact memory recall via 8 pin DIN socket.
Options	◆ = Transformers available. Delay Option, Relay bypass. Digital I/O.

Due to continuing product improvement the above specifications are subject to change.

Operating Notes

Operating Level

With any audio signal processing equipment it is necessary to ensure adequate signal level is used through the device, to avoid sacrificing noise performance. The DP202 features a menu selectable choice of operating levels to reduce this problem, (see page 10). It is suggested that the operating level chosen should give adequate level to just light the 6dB LED on the headroom meter with maximum program level being used. Since the meter is deliberately set to 'over-read' by 3dB, this still provides 9dB of headroom before clipping occurs. With equalisation in use it may be necessary to further reduce the input level, as gain within the unit may cause digital clipping, indicated by the top red LED's lighting.

It should be noted that the figure quoted for the maximum input level options is the clipping point for that option (not a safe operating level). Always ensure that this clipping point is no lower than that for the following equipment in the signal chain, and allow extra margin if equalisation sections are boosted.

Grounding. The Screen (shield) pins on all audio connectors are normally connected directly to the ground pin of the IEC mains inlet. The chassis is also directly connected to this pin. Never operate this unit without the mains safety ground connected. Signal ground (0V) is in turn connected to the chassis ground.

To avoid ground loops, cable shields should be connected to ground at one end only. The normal convention is that the shield is only connected at the output XLR. Provision is also made for separately isolating each input and output shield pin permanently within the DP200 by breaking the appropriate PCB track, where marked with a box and an 'X' next to each XLR connector using a small drill bit or cutter. See the following diagram for details.

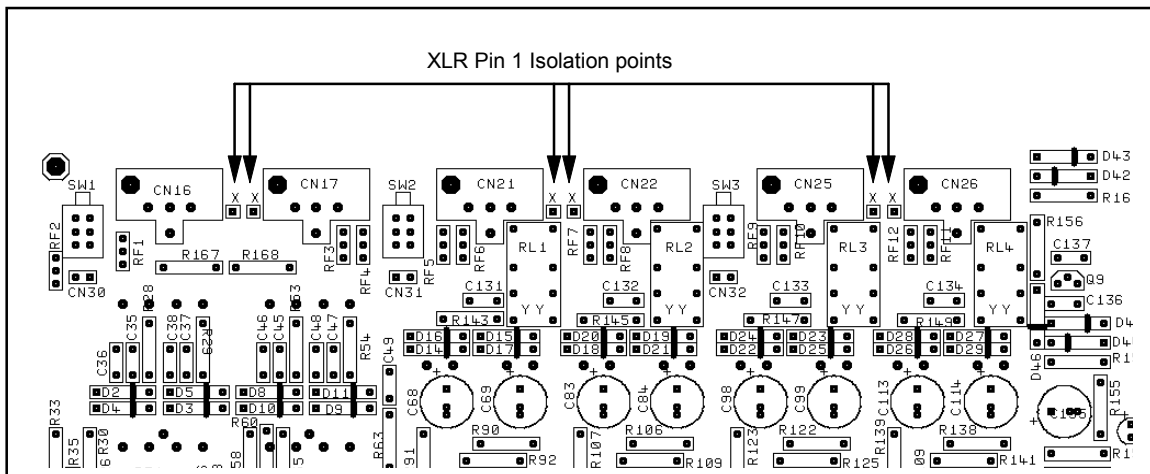

Figure 7 - XLR pin 1 Isolation points

Warranty

This product is warranted against defects in components and workmanship only, for a period of one year from the date of shipment to the end user. During the warranty period, XTA will, at its option, either repair or replace products which prove to be defective, provided that the product is returned, shipping prepaid, to an authorised XTA service facility.

Defects caused by unauthorised modifications, misuse, negligence, act of God or accident, or any use of this product that is not in accordance with the instructions provided by XTA, are not covered by this warranty.

This warranty is exclusive and no other warranty is expressed or implied. XTA is not liable for consequential damages.